

HARDCOTE

*ARCHITECTURAL MOULDINGS
& AWNINGS*



CATALOGUE RANGE

*EFFICIENT AND COST EFFECTIVE
BUILDING SOLUTIONS*

PHONE: (07) 5471 7786

Contents

3 Dimensional Signs, Logo's and Sign Frames	Page 1
Awnings	Page 2
Keystones and Corner Quoins	Page 3
Columns and Column bases	Page 4
Decorative Dental Moulds	Page 5
Arches and Arched Features	Page 6
Louvered shutters and Vents	Page 7
Step moulds	Page 8
Profiled Architectural Mouldings range	Page 9-18

For all enquiries and further information please call
(07) 5471 7786

www.hardcote.com.au

email: info@hardcote.com.au



Make your business stand out with a 3 dimensional shop front sign and logo. Call HARDCOTE now for a free quote

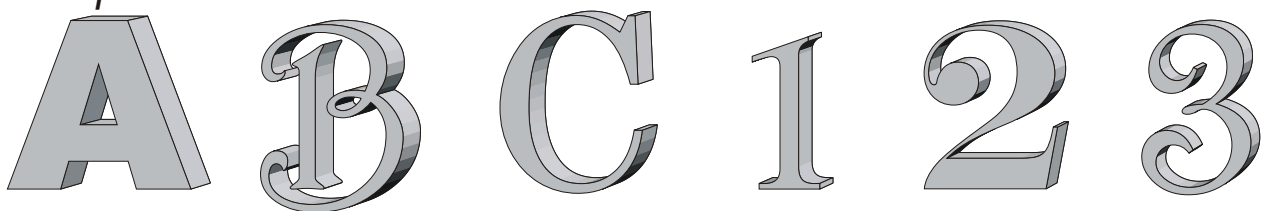

email: info@hardcote.com.au Phone: (07) 5471 7786
3/37 Access Crescent, Coolum Beach. Qld, 4573

HARDCOTE A WNING SYSTEM

200mm Thick

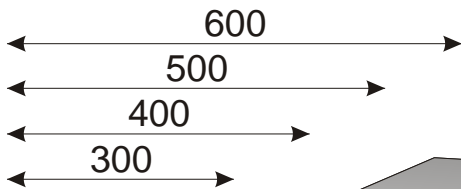
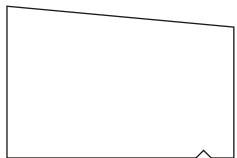
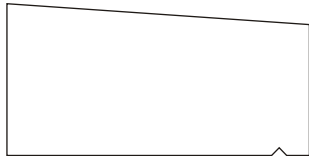
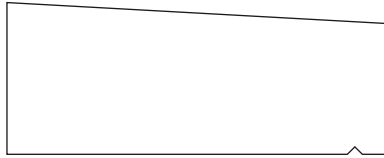
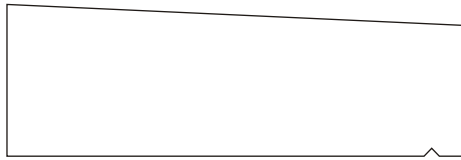

150mm Thick

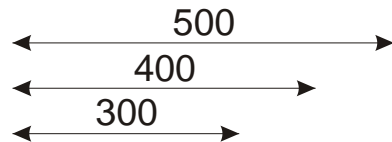
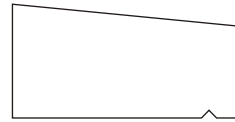
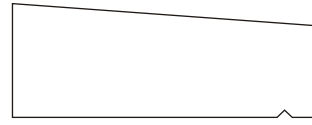
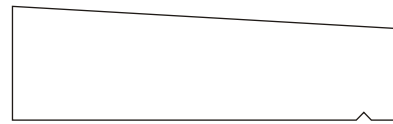

Please refer to pages 1 and 2 of the Hardcote picture brochure for further information about our Awnings

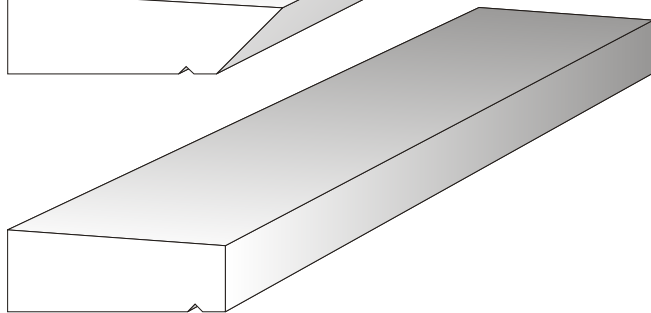
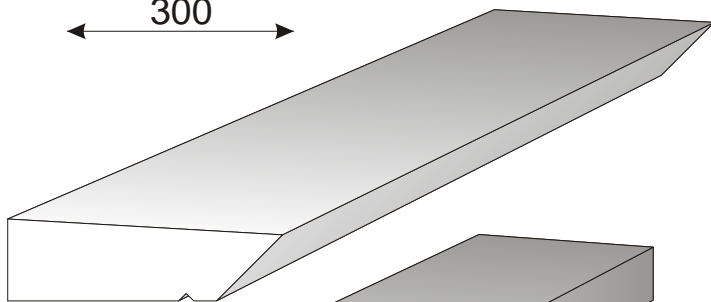

BR1



Galvanised Steel Awning support brackets are made to suit.

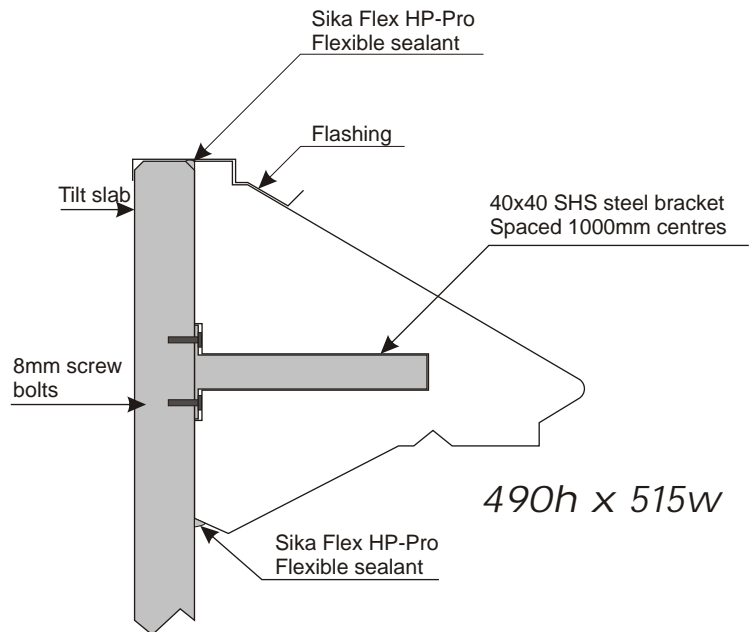

A Great tilt slab building option.

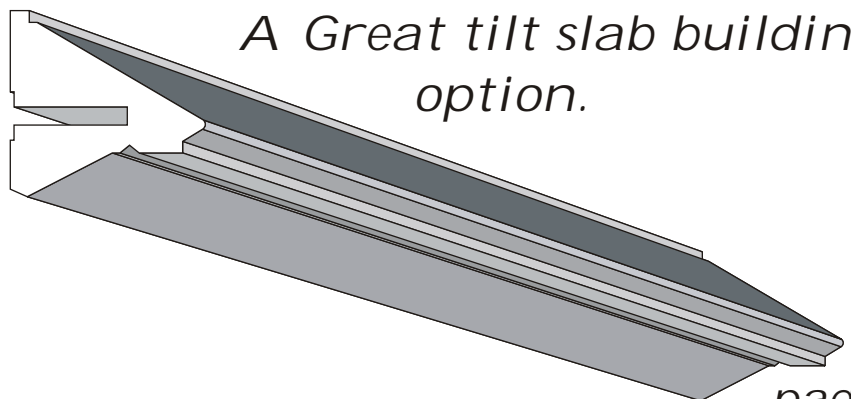

KEYSTONES AND CORNER QUOINS

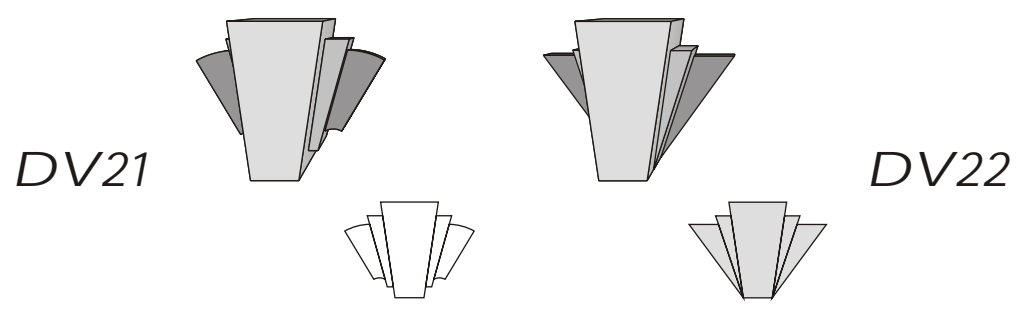
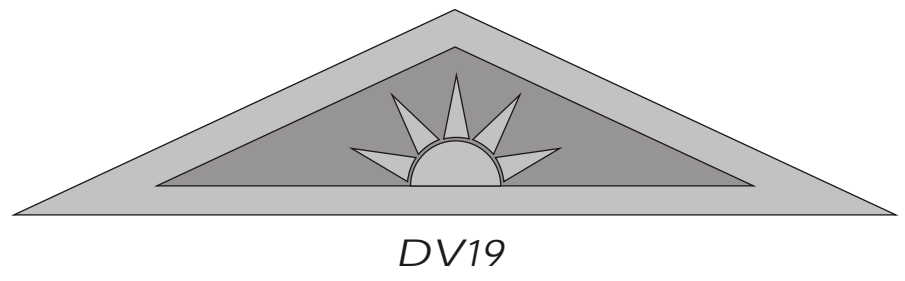
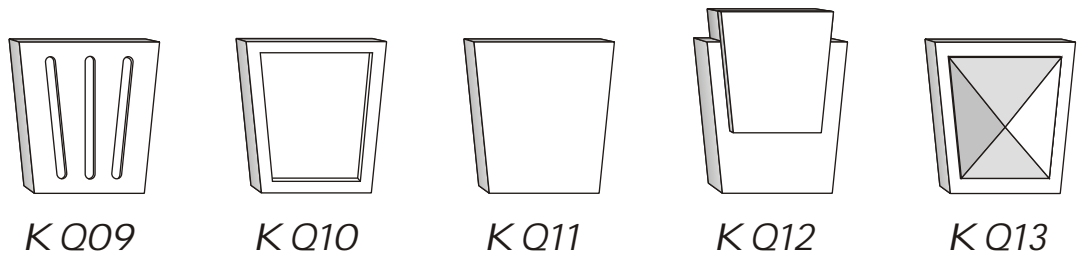
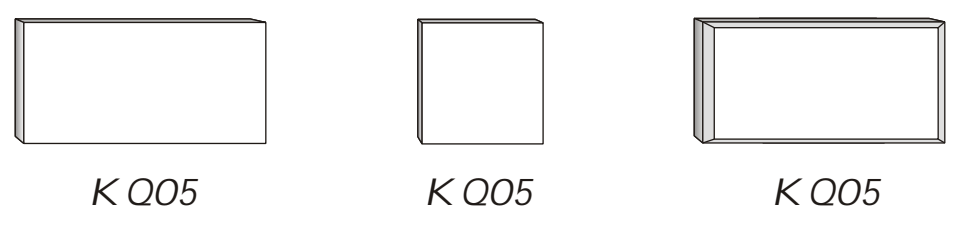
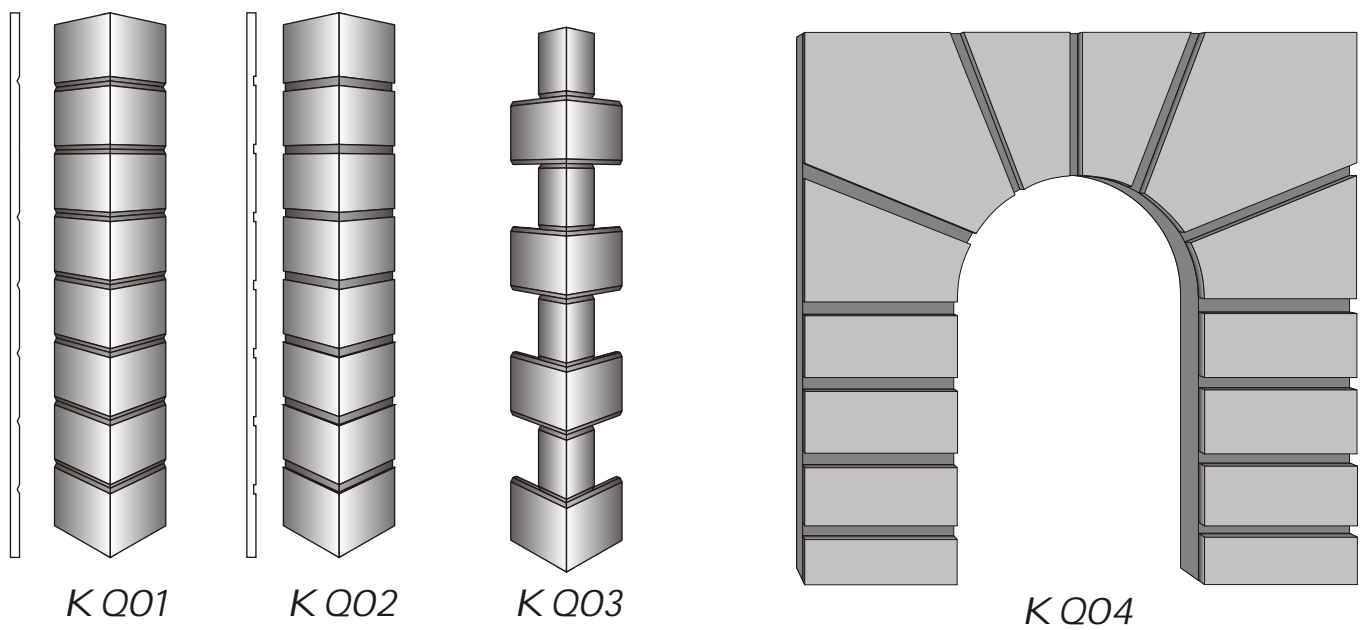

Columns and column bases

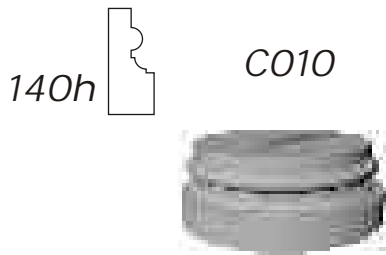
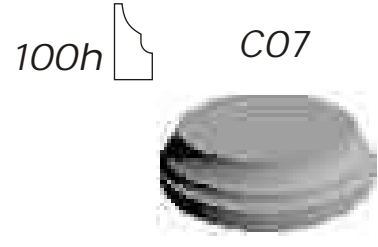
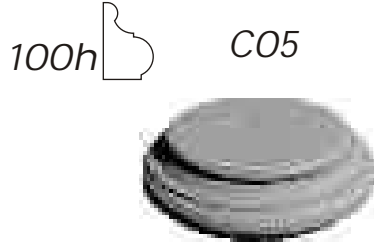
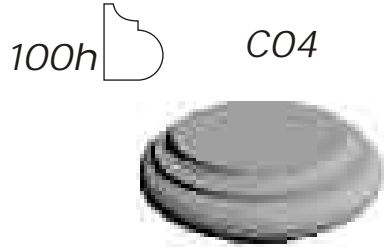
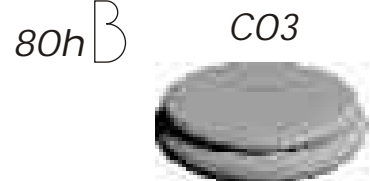
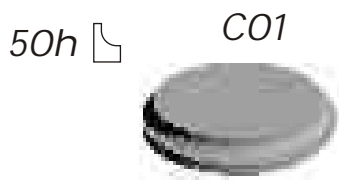

Mix and match our columns with bases or custom design your own unique style of base and column



c13

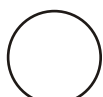

c19

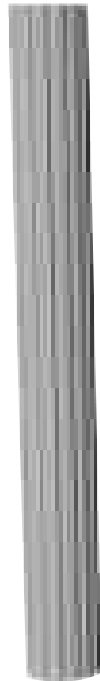

c14

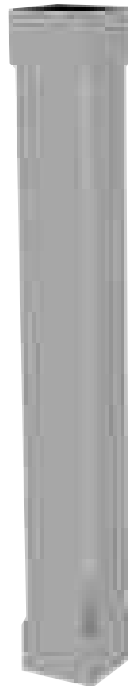

c20

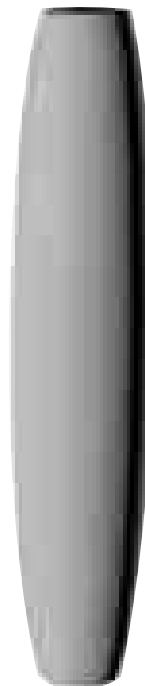

Tapered



Call Hardcote and specify the dimensions and style for a Price or refer to our price list for standard size prices

Custom Dental Mould

Custom Design your own unique dental moulds.

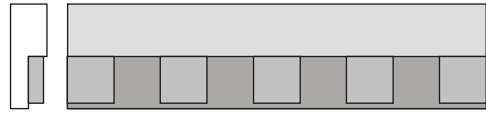
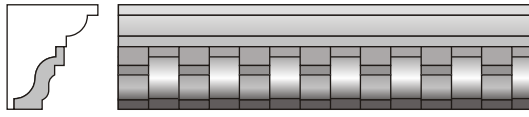
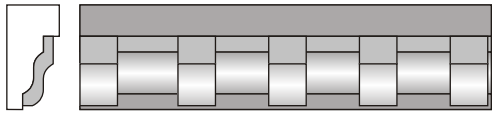

DF109

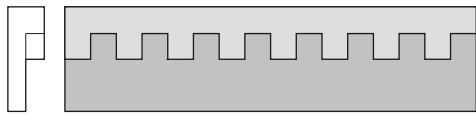

DF110

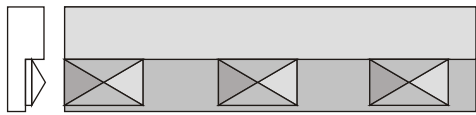

DF111

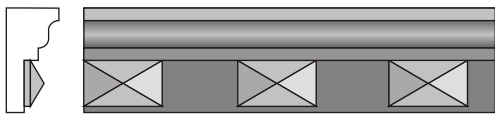

DF112

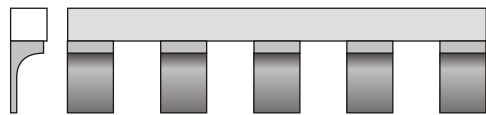

DF117

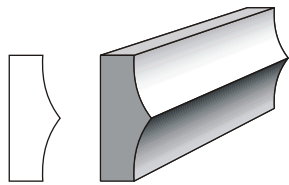
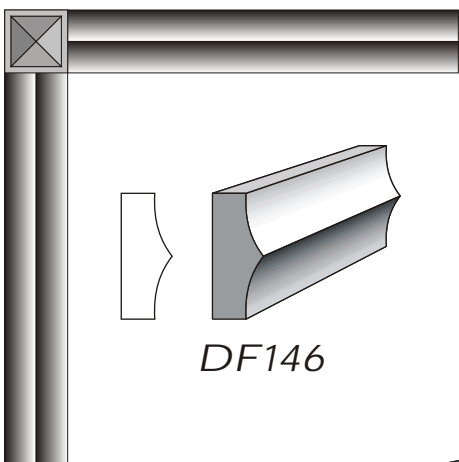

DF146

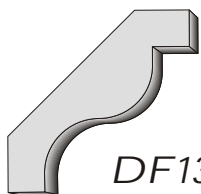

DF136

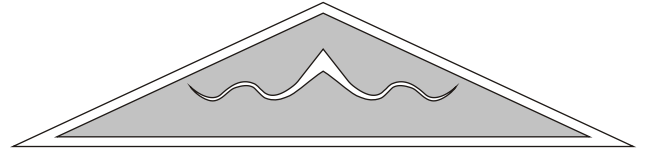

DF141

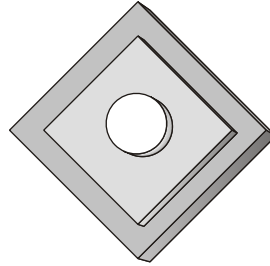

DF157

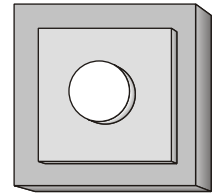

DF158

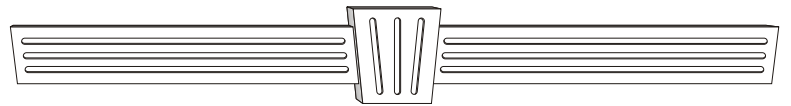

DF138

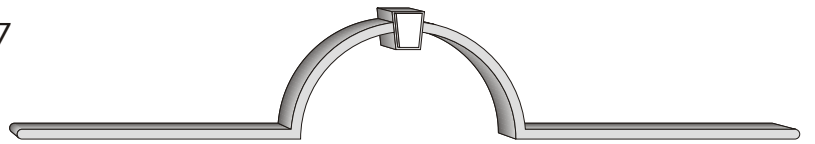

K Q14

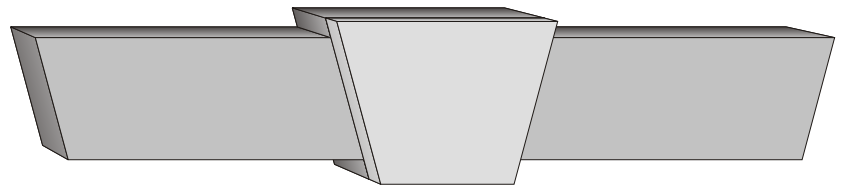

K Q15

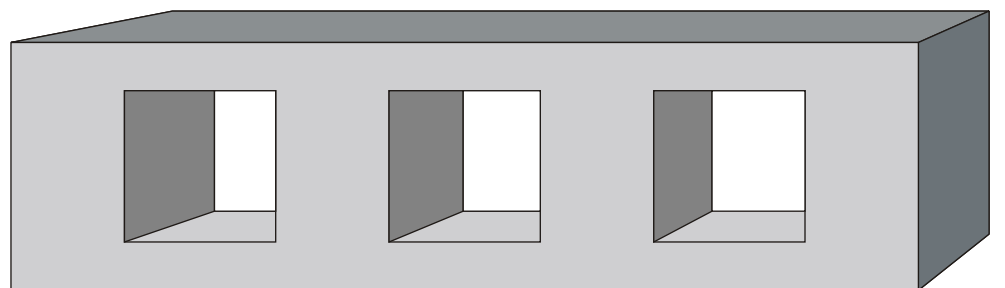

DF114

ARCHES

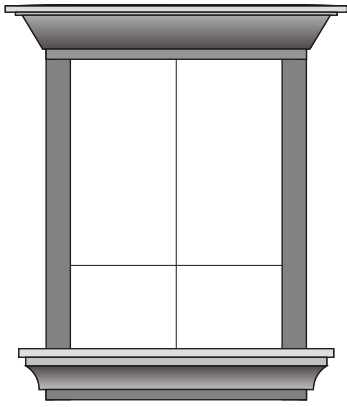

DF143

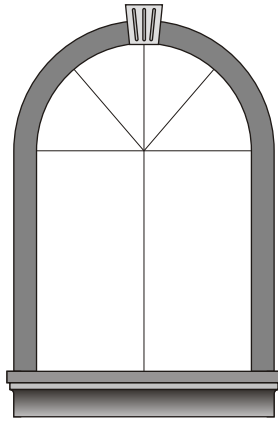

DF145



DF148

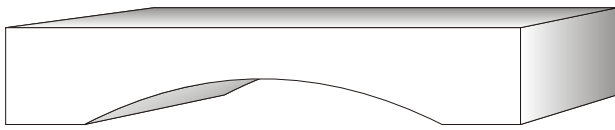

DF154

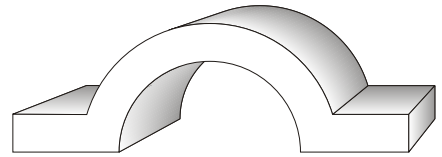

DF154



DF150

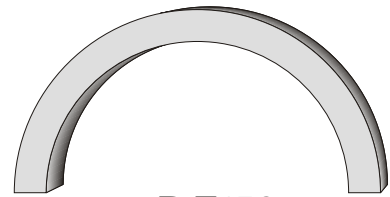

DF152

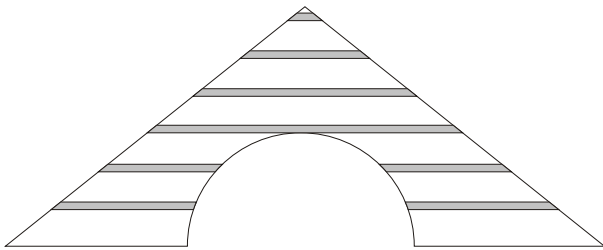

DV16

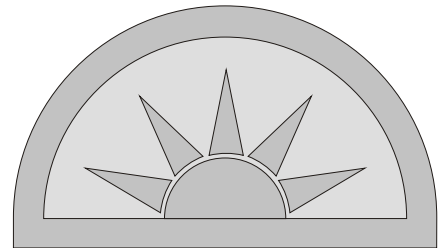

DV18

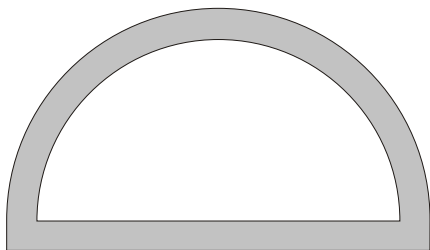

DV20

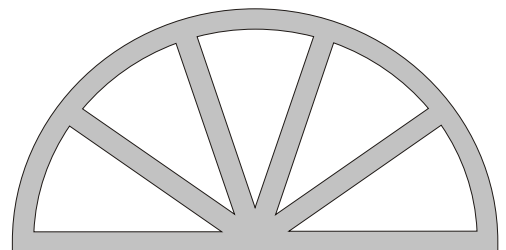

DV17

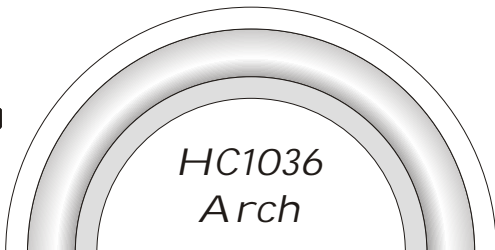

HC1036
Arch

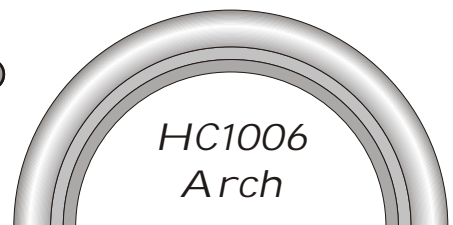

HC1006
Arch

Any mould from our catalogue can also be an arch

LOUVERED SHUTTERS AND VENTS

(Decorative Moulds only)

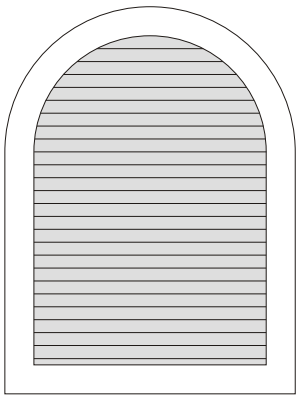

DV01

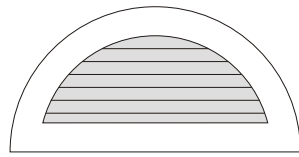

DV02

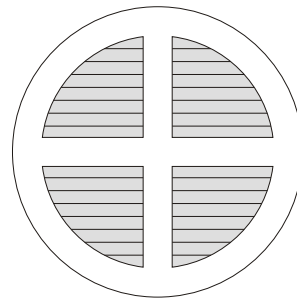

DV03

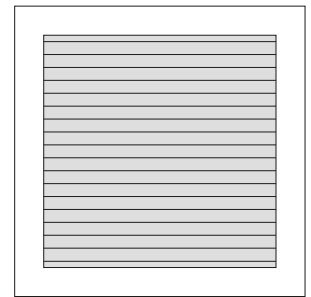

DV04

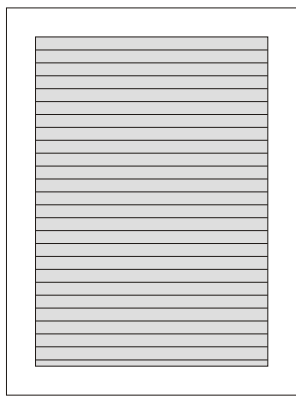

DV05

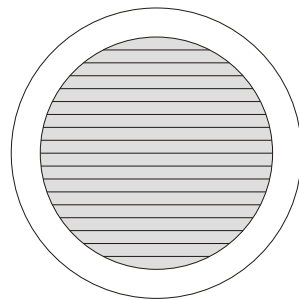

DV06

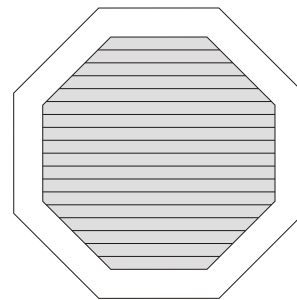

DV07

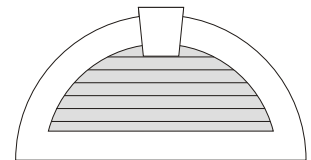

DV08

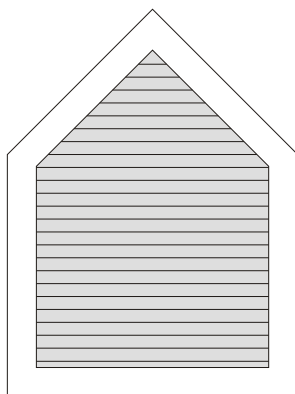

DV09

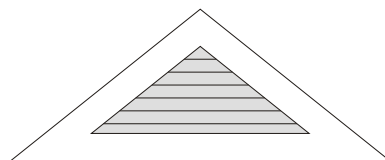

DV10

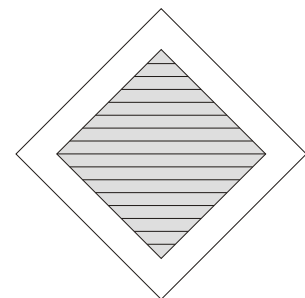

DV11

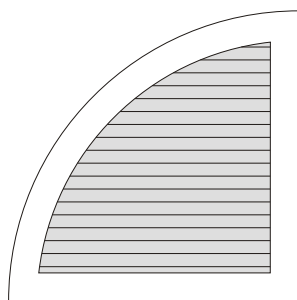

DV12

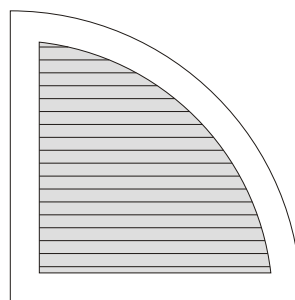

DV13

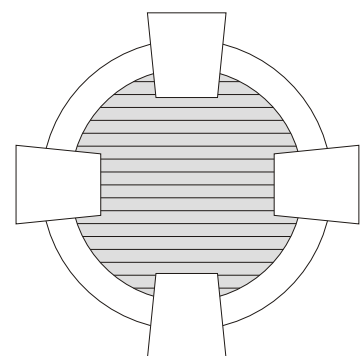

DV14

STEP MOULDS

300x300

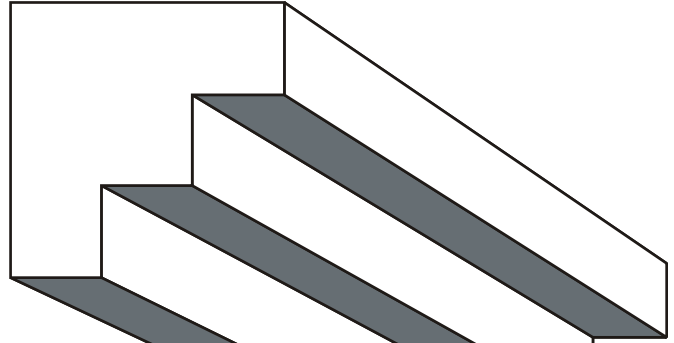
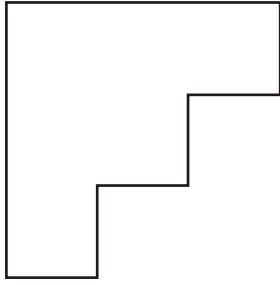

100x100

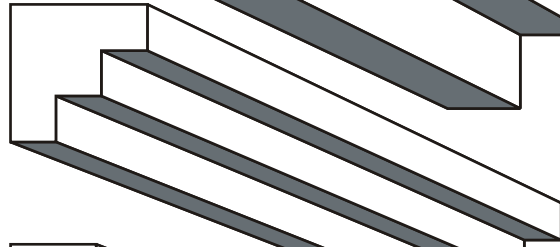
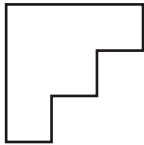

300x90

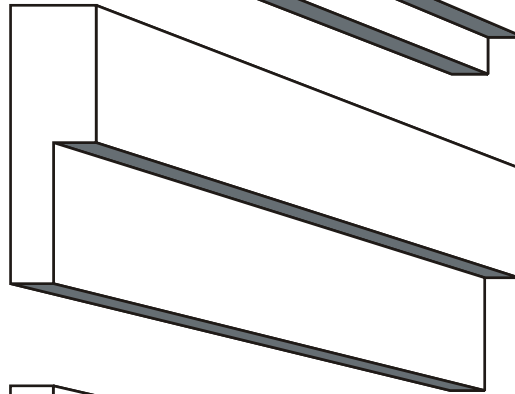

100x30

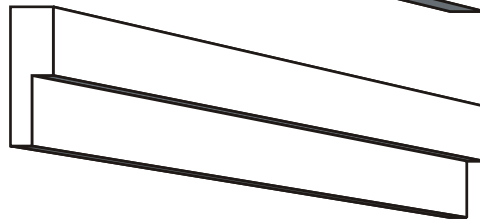

2 Step Mould

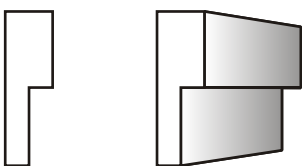

Wide 2 Step Mould

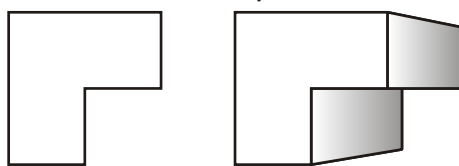

3 Step Mould

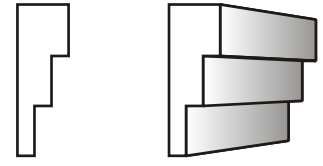

Step moulds are made to suit your size requirements

Wide 3 Step Mould

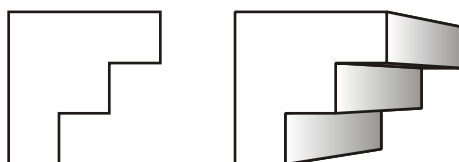

Any shape any size

Profile range

HC1001

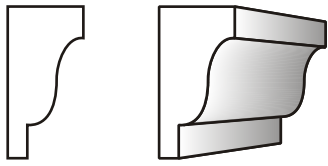

100h x 50w

HC1002

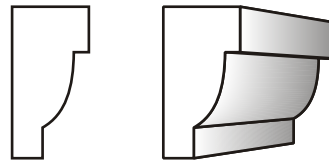

100h x 50w

HC1003

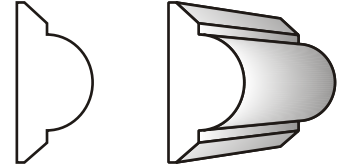

100h x 50w

HC1004

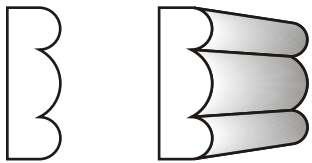

100h x 50w

HC1005

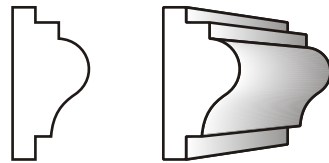

100h x 35w

HC1006

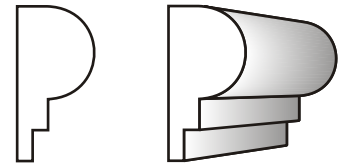

100h x 50w

HC1007

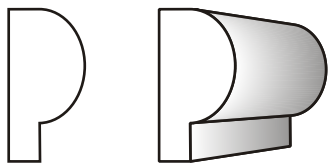

100h x 50w

HC1008

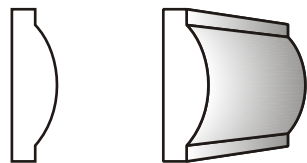

100h x 30w

HC1009



100h x 30w

HC1010

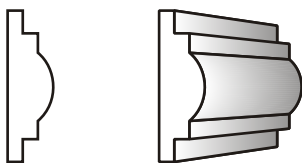

100h x 30w

HC1011

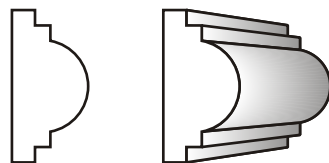

100h x 50w

HC1012

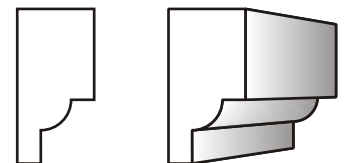

100h x 50w

HC1013

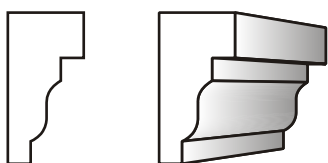

100h x 50w

HC1014

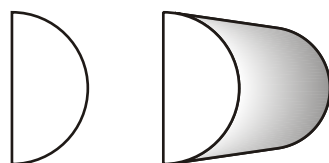

100h x 50w

HC1015

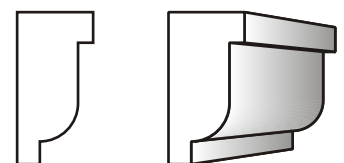

100h x 50w

HC1016

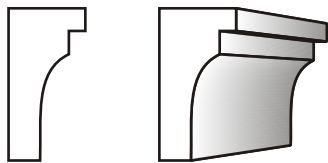

100h x 50w

HC1017

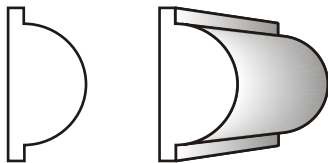

100h x 50w

HC1018

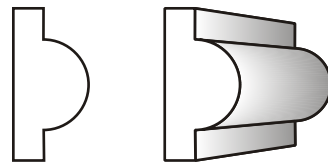

100h x 50w

HC1019



100h x 47w

HC1020

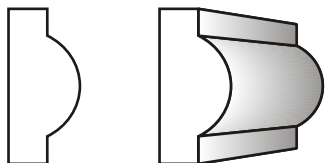

100h x 45w

HC1021



100h x 60w

HC1022

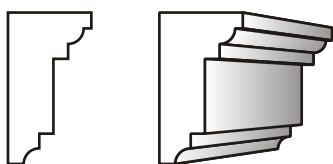

100h x 55w

HC1023

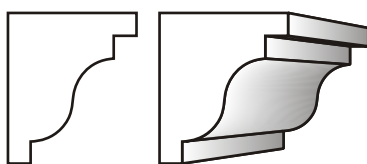

100h x 85w

HC1024



100h x 46w

HC1025

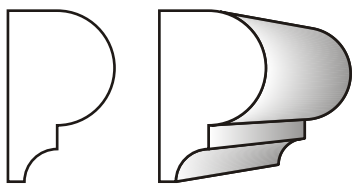

113h x 70w

HC1026

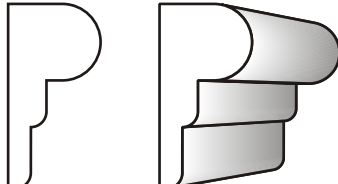

120h x 60w

HC1027

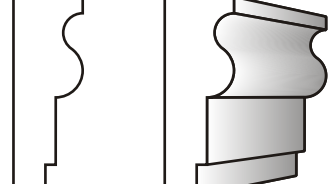

130h x 45w

HC1028

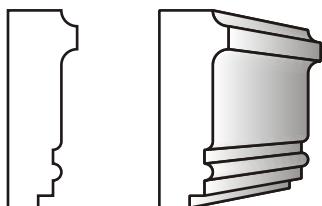

130h x 45w

HC1029

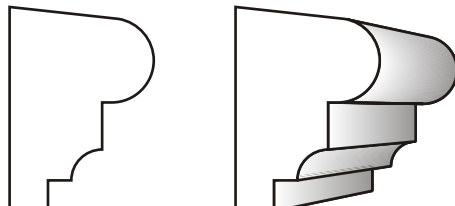

135h x 95w

HC1030

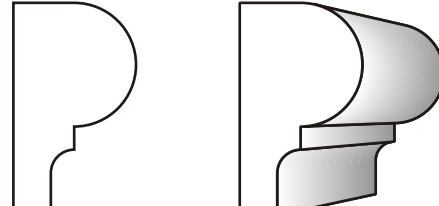

140h x 80w

HC1031

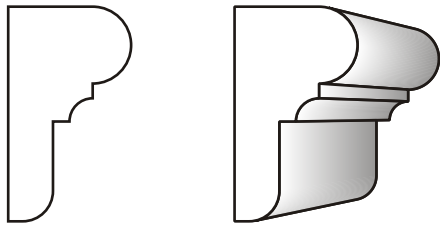

140h x 80w

HC1032

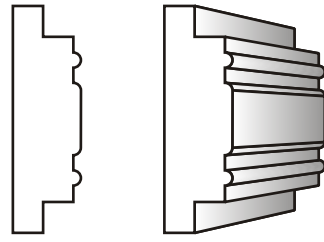

150h x 45w

HC1033

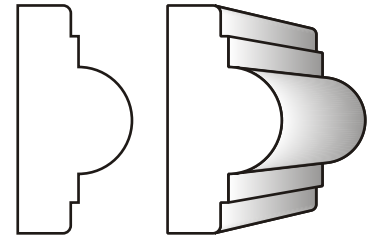

150h x 75w

HC1034

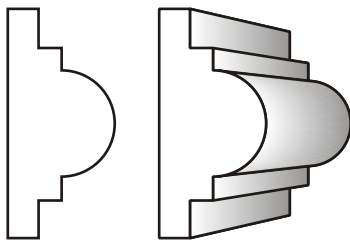

150h x 70w

HC1035

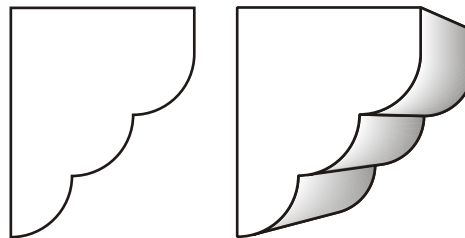

150h x 120w

HC1036

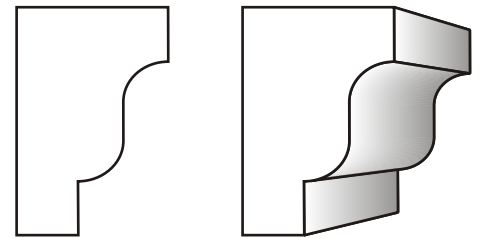

150h x 100w

HC1037

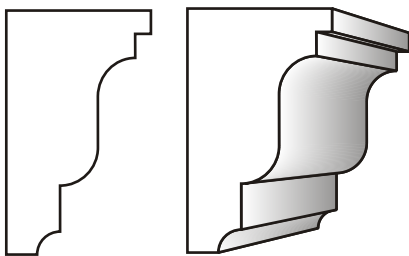

160h x 95w

HC1038

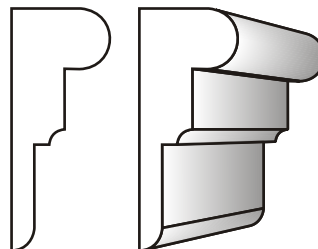

160h x 65w

HC1039

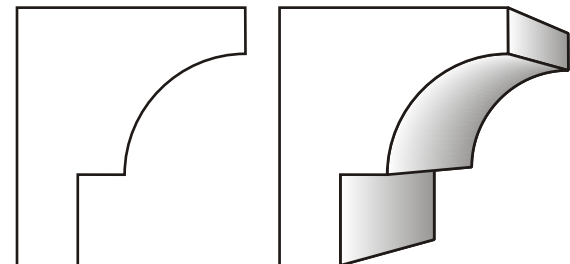

170h x 150w

HC1040

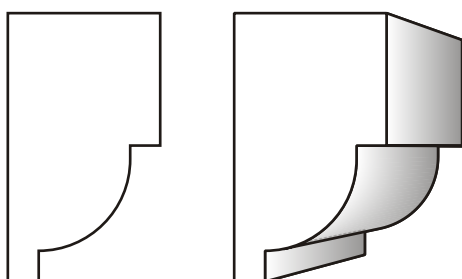

177h x 100w

HC1041

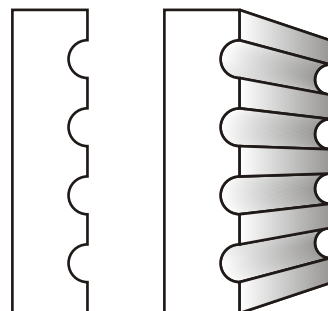

200h x 50w

HC1042

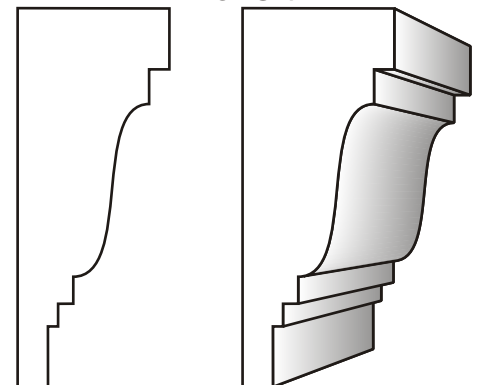

250h x 100w

HV1043

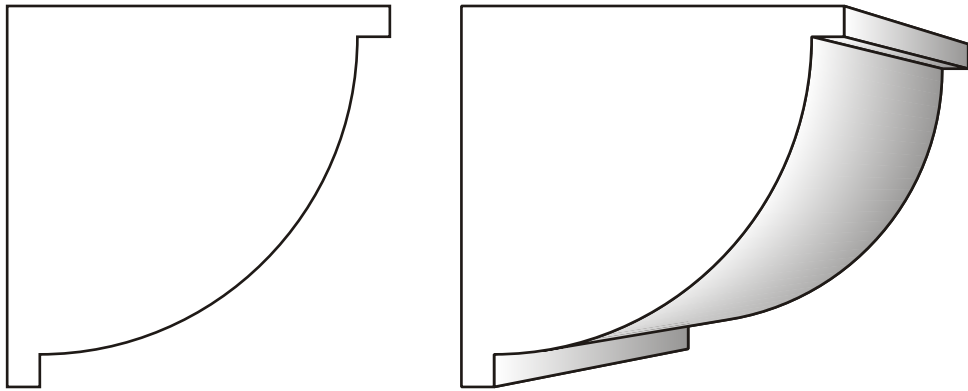

250h x 250w

HC1044

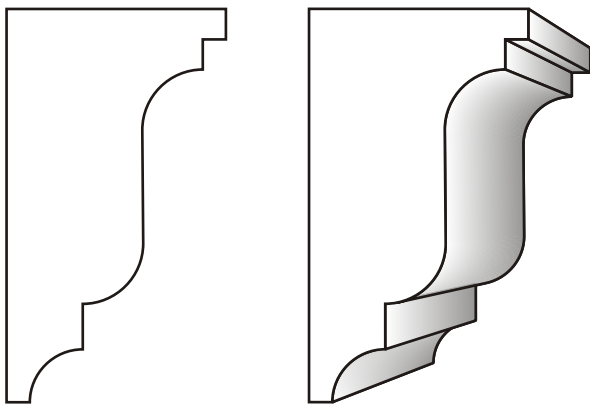

260h x 145w

HC1045

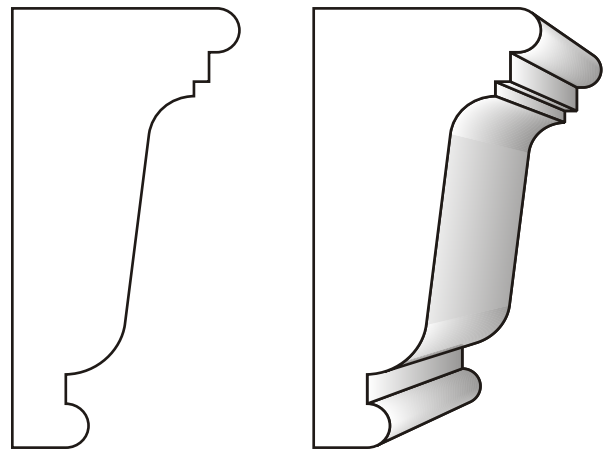

290h x 150w

HC1046

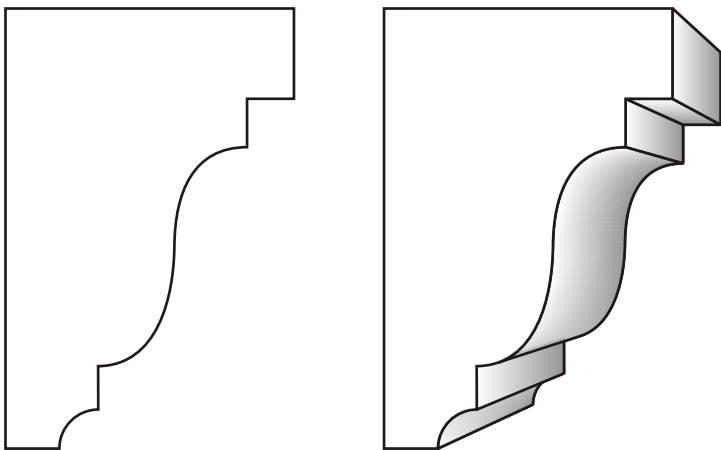

290h x 190w

HC1047

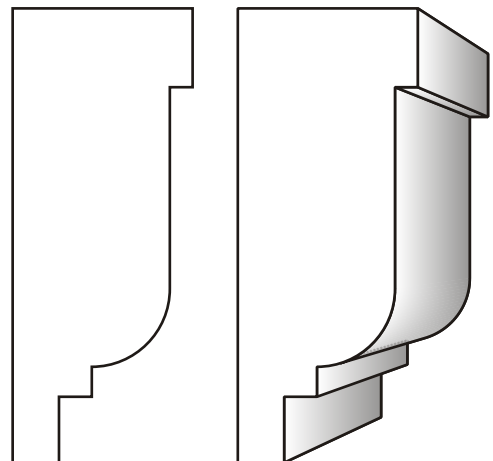

300h x 118w

HC1048

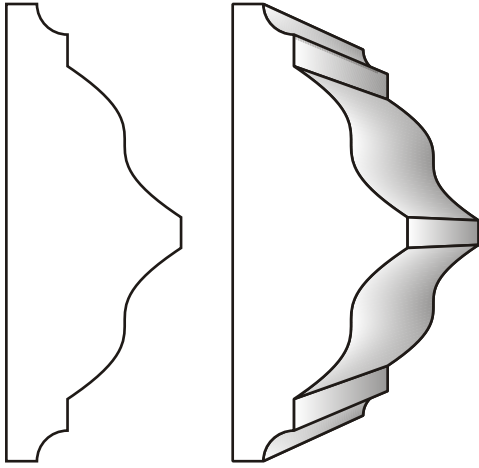

300h x 115w

HC1049

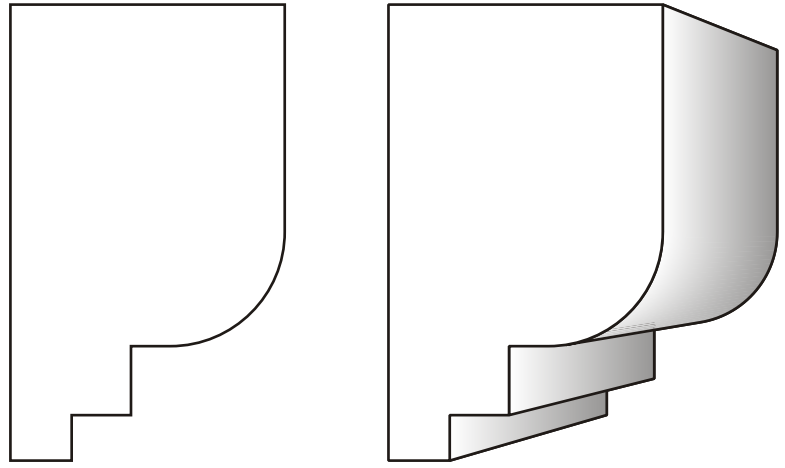

300h x 180w

HC1050

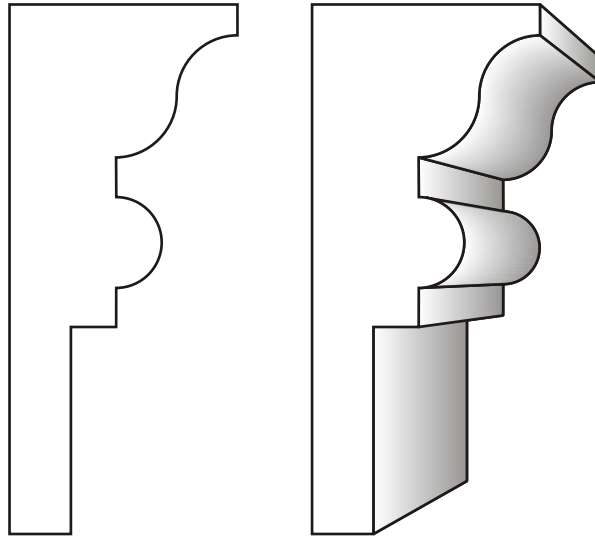

300h x 115w

HC1068

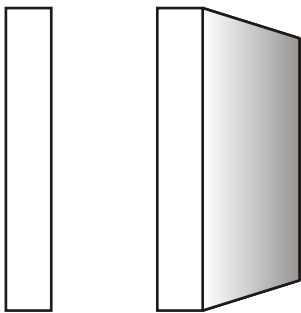

200h x
50w
30w
25w
20w

HC1069

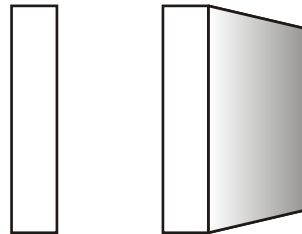

150h x
50w
30w
25w
20w

HC1070

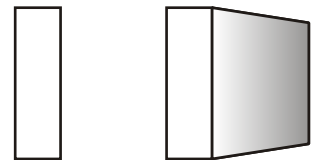

100h x
50w
30w
25w
20w

HC1064

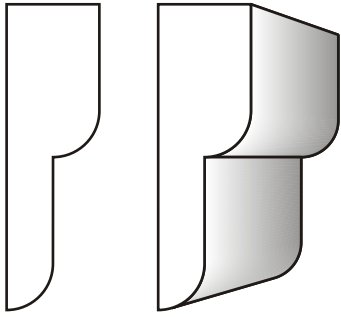

200h x 60w

HC1065

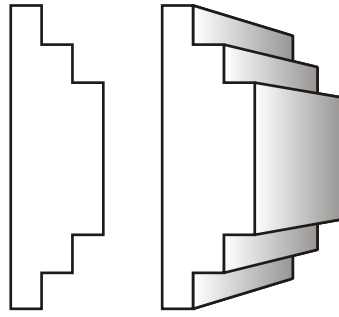

200h x 60w

HC1066

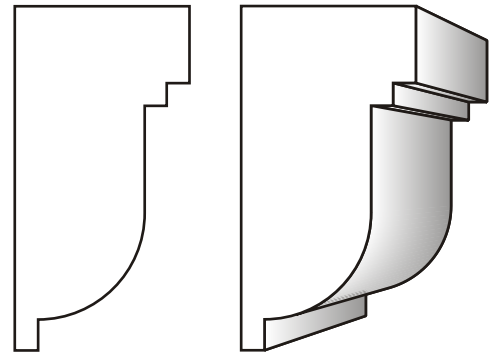

227h x 115w

HC1067

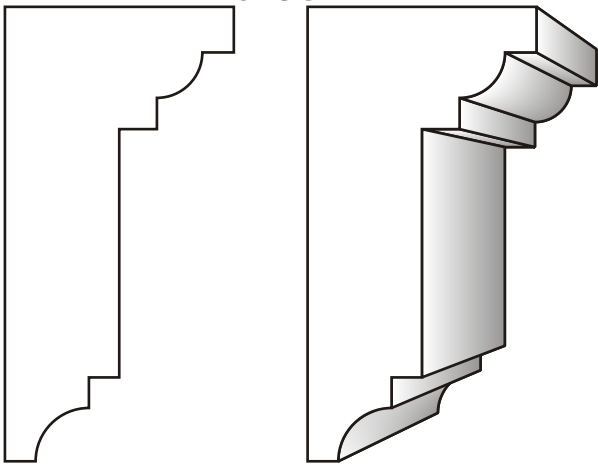

300h x 150w

Pier Caps

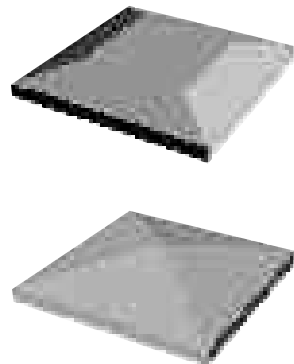

c12

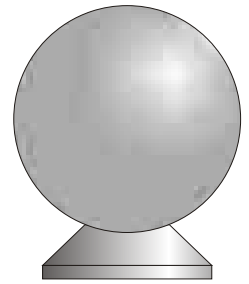

DF144

Customised Capping Moulds

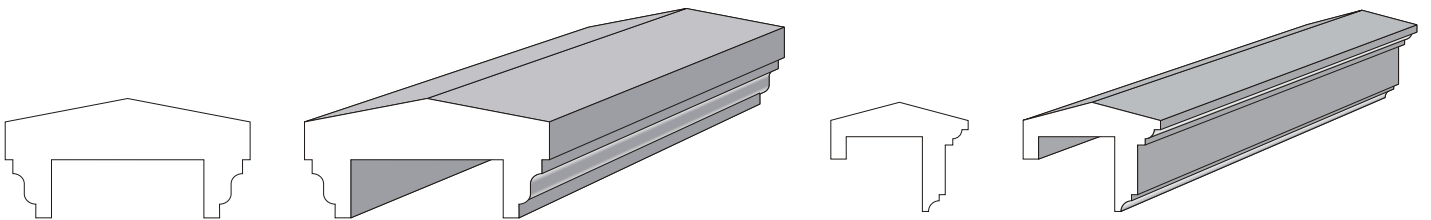

Customise your own fence capping mould using any shape from our catalogue. Suitable for all styles of fences, balconies, Retainer walls and Parapet walls.

HC1071

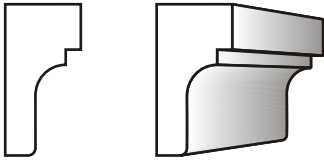

100h x 50w

HC1072

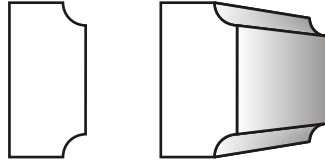

100h x 50w

HC1074

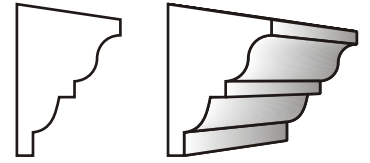

100h x 68w

HC1075

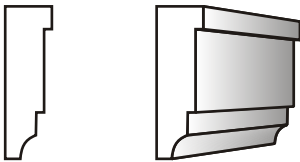

100h x 30w

HC1077



100h x 30w

HC1081

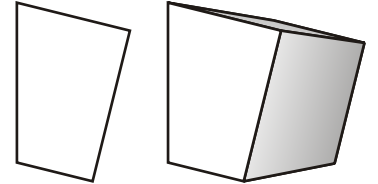

100h x 70w

HC1084

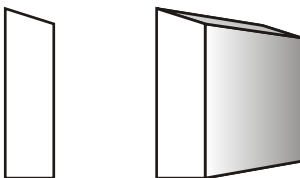

110h x 30w

HC1086

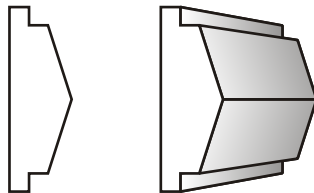

120h x 40w

HC1087

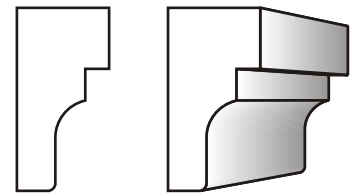

120h x 60w

HC1089

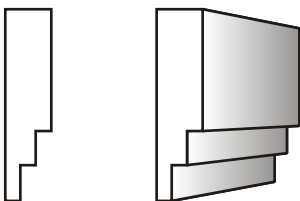

125h x 30w

HC1090

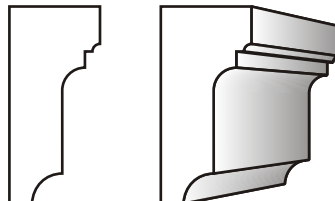

130h x 60w

HC1092

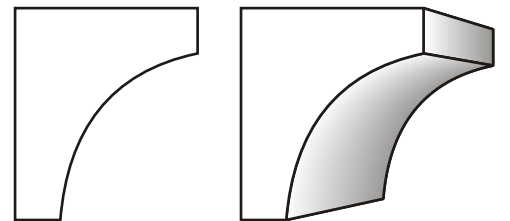

140h x 120w

HC1090

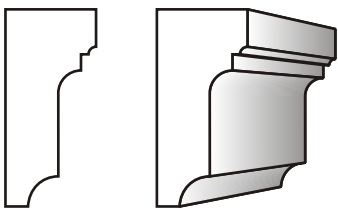

130h x 60w

HC1092

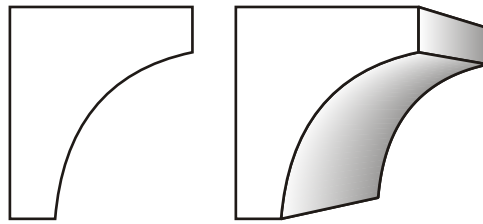

140h x 120w

HC1094

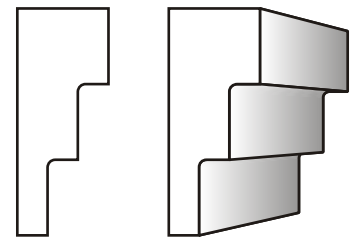

150h x 60w

HC1095

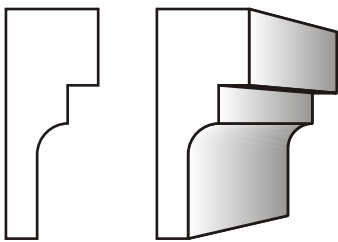

150h x 60w

HC1096

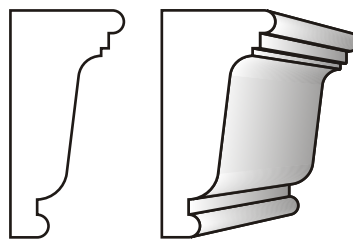

150h x 75w

HC1101

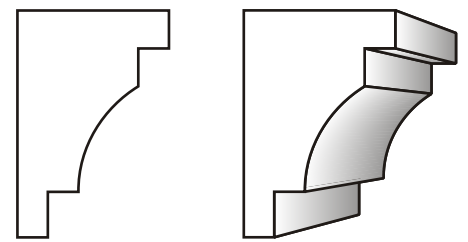

150h x 100w

HC1102

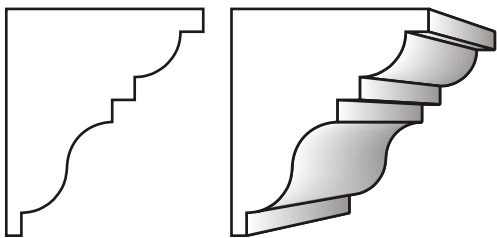

152h x 130w

HC1103

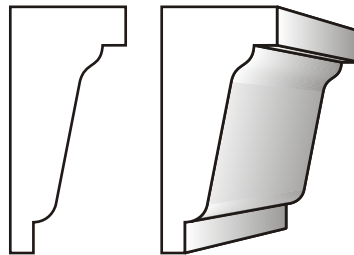

160h x 75w

HC1104

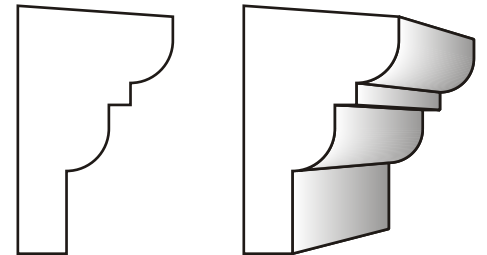

160h x 100w

HC1105

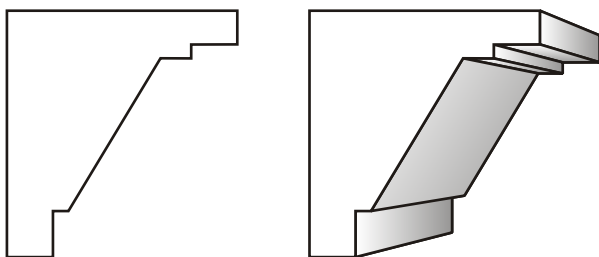

160h x 150w

HC1106

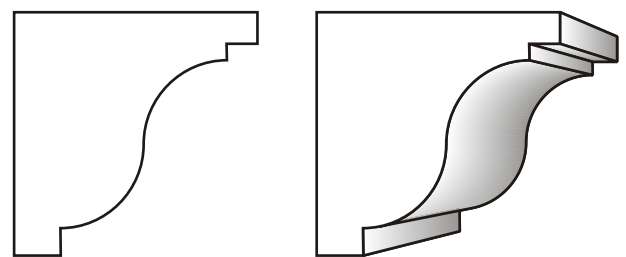

160h x 160w

HC1107

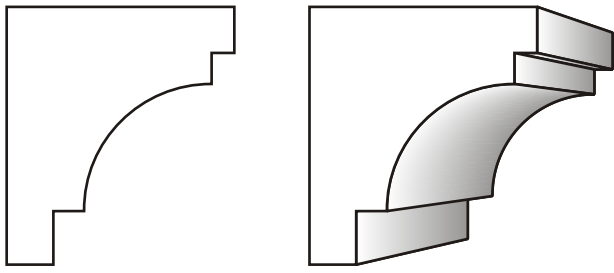

170h x 150w

HC1115

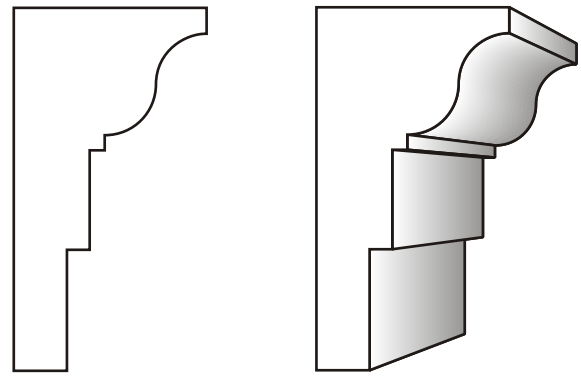

240h x 127w

HC1116

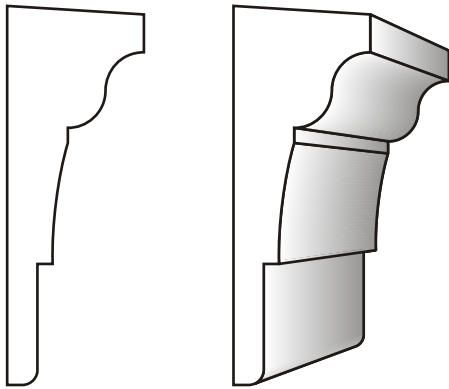

250h x 90w

HC1117

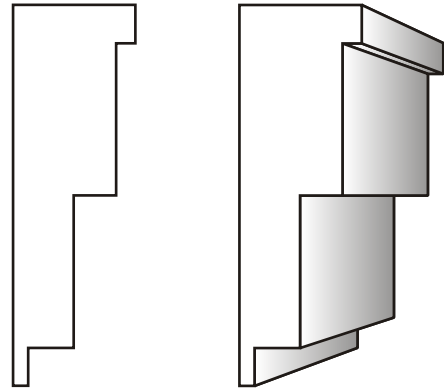

250h x 80w

HC 1122

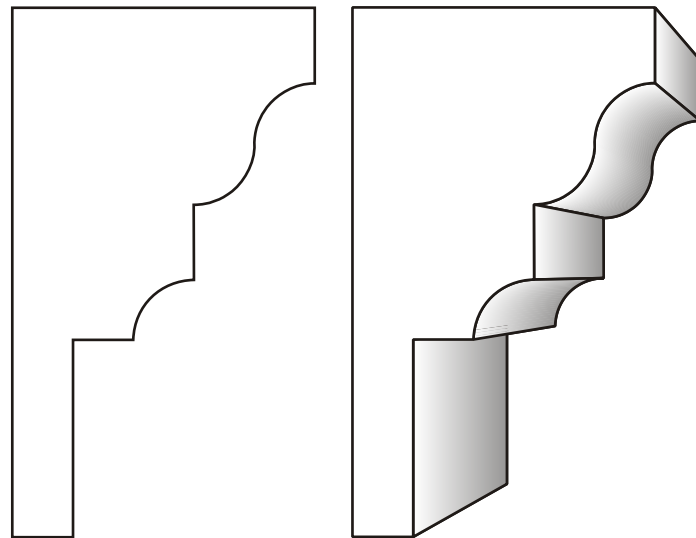

350h x 200w

HC1123

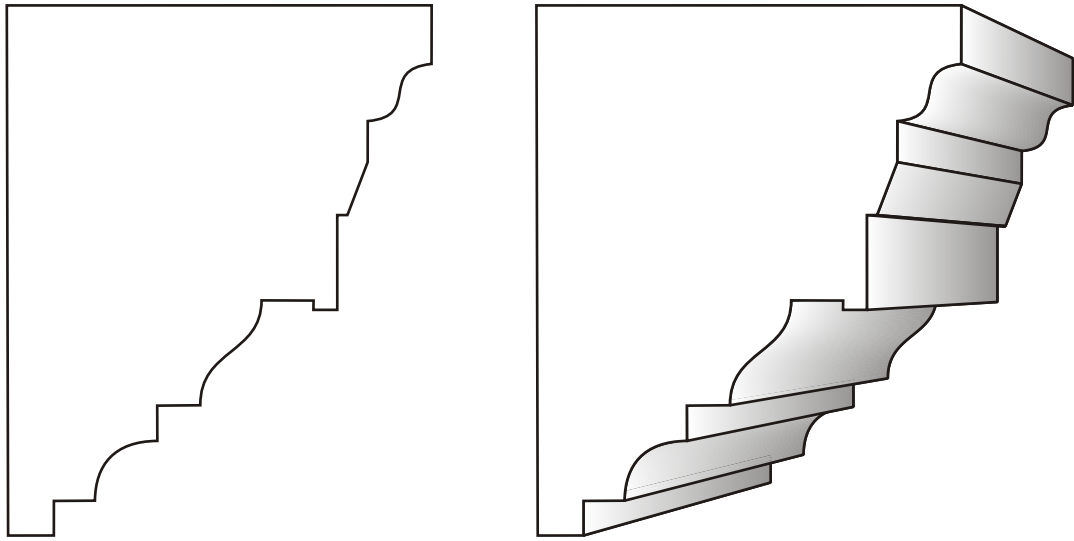

350h x 280w

HC1124

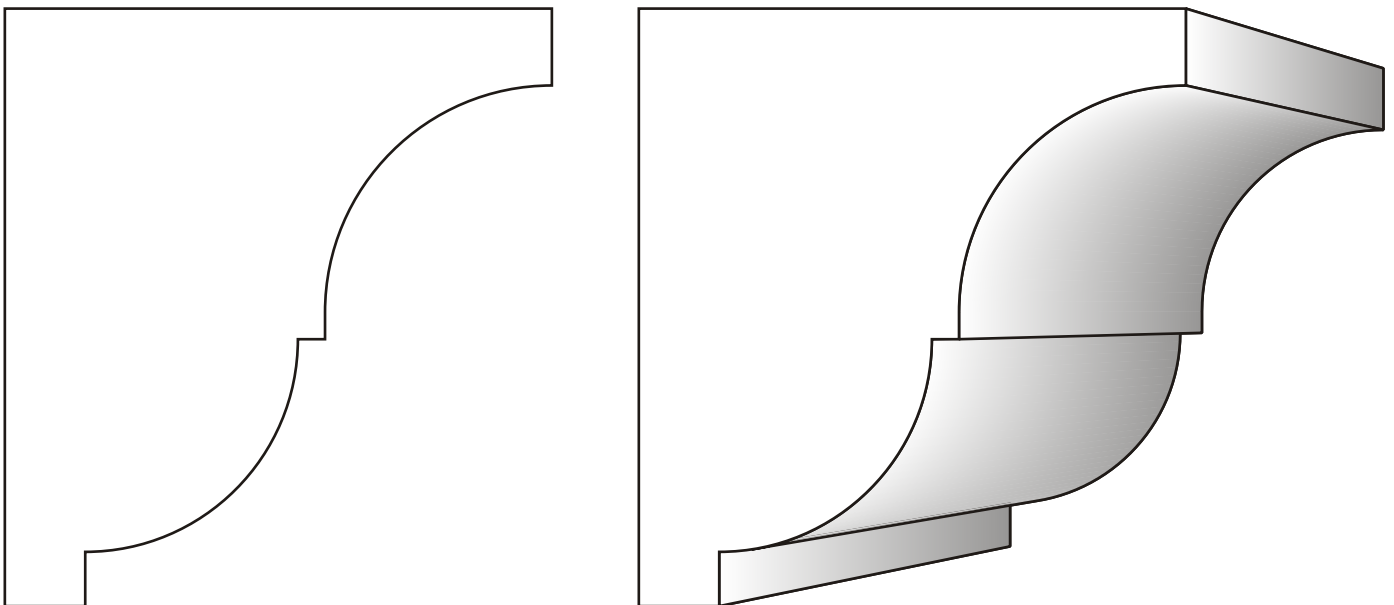

395h x 360w

All profiles are accurately computer cut. Designing your own mould to suit your requirements or resizing any of ours are easily done with our CAD software.

www.hardcote.com.au

email: info@hardcote.com.au

Head Office

**3/37 Access Crescent
Coolum Beach QLD 4573**

Phone: (07) 5471 7786